



DoorBird
Technology meets Design.



A1101

IP VIDEO INDOOR STATION

For door communication in single-family residences
and apartment buildings

Designed,
developed and
made in Germany



The DoorBird IP Video Indoor Station is an ideal addition to any DoorBird system. When paired with our DoorBird IP Video Door Intercom, the Indoor Station delivers a live video stream, two-way audio communication as well as control of doors and gates. The Indoor Station is compact and designed to complement any environment.

The DoorBird Indoor Station has a touch display made of scratch-resistant tempered glass with intuitive user interface. It also includes configurable hard buttons with clear symbols for common functions.

This makes the operation

- intuitive and comfortable
- easy-to-use for every age group
- even with gloves on possible

Individual chime alerts can be selected for multiple DoorBird Door Intercoms to indicate from which entry the visitor is calling. When the DoorBird Door Intercom is rung, an LED light at the bottom of the Indoor Station flashes a visual alert. The color of the LED light can be customized for multiple DoorBird Door Intercoms.

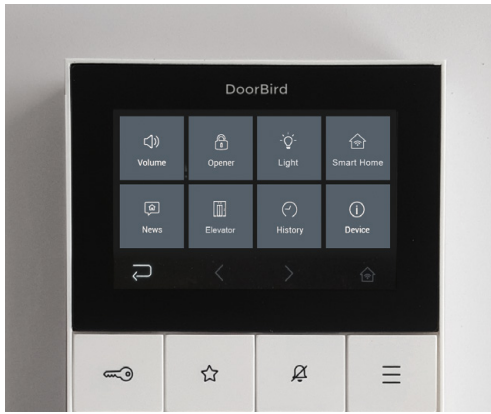

Configurable tile view



Weather information



Table Stand "A8003" optional

In less than 10 minutes the installation of the Indoor Station is completed. The DoorBird Indoor Station can connect to the network via WiFi or a network cable. If the Indoor Station is connected using a network cable, it can be powered via Power over Ethernet (PoE) for quick and easy installation. Should the Internet fail, all functions continue to operate within the local network. Once on the Internet, the Indoor Station can connect you to all your DoorBird Door Intercoms - anywhere in the world.

FEATURES

Benefits via IP

- Door opener and elevator control
- Visitor history (free Cloud Recording)
- Weather forecast display
- Home and building automation control (IP, TCP, HTTPS, relays etc.)
- Configurable via the DoorBird App worldwide

Intuitive User Interface

- 4" True Color Touch Display
- Scratch-resistant tempered Gorilla® glass

Two-way Audio Communication

- HD Audio, up to 102 dB
- More than 50 doorbell sounds available

Compact Housing

- 5 hardware buttons for main functions
- Configurable RGB LED status bar

Unlimited Range

- Supports WiFi, Ethernet, PoE
- Support for multiple DoorBird IP Video Door Stations

Further Options

- Automatic door opening system, e.g. for offices
- SIP and PBX support

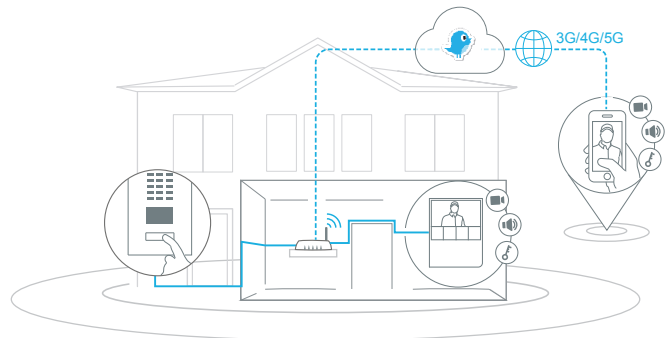

further installation examples s. page 5

GENERAL

Mounting type	Surface-mounted, Table Stand "A8003" sold separately
Power supply	15 - 48 V DC (max. 15 W) or Power over Ethernet (PoE 802.3af Mode-A)
Weight	336 g
Connectors	<ul style="list-style-type: none"> • LAN/PoE (T+, T-, R+, R-) • Digital input (0 V, 0 A (NO)) #1, e.g. for storey-call button • Digital input (0 V, 0 A (NO)) #2, e.g. for second storey-call button • Bi-stable latching relay #1, max. 24 V DC/AC, 1 Ampere, e.g. for electric door opener or elevator • Bi-stable latching relay # 2, max. 24 V DC/AC, 1 Ampere, e.g. for electric door opener or elevator • Bi-stable latching relay # 3, max. 24 V DC/AC, 1 Ampere, e.g. for electric door opener or elevator • 15 - 48 V DC input (+, -), max. 15 W
Power consumptions	5 W
Approvals	CE, FCC, IC, RoHS, IP50
Dimensions	179.5 x 115 x 25 mm (H x W x D) 7.07 x 4.53 x 0.98 in (H x W x D)
Operating conditions	0 to +55°C / 32 to 131°F Humidity 0 % to 85 % (non condensing)
Scope of delivery	<ul style="list-style-type: none"> 1 x IP Video Indoor Station 1 x Mounting bracket 1 x Power supply unit (main adaptor) with four country-specific adaptors (110 - 240 V AC to 15 V DC) 1x Quickstart guide with Digital Passport 1 x Installation manual 1 x Small parts
EAN	4260423860902
Warranty	see www.doorbird.com/warranty

INTEGRATED WIRELESS MODULES

WiFi 802.11 b/g/n 2.4 GHz

OPTIONAL ACCESSORIES

Sold separately see www.doorbird.com/buy

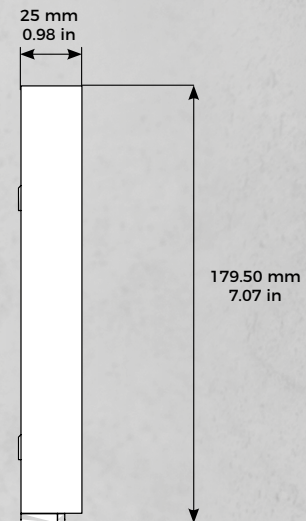
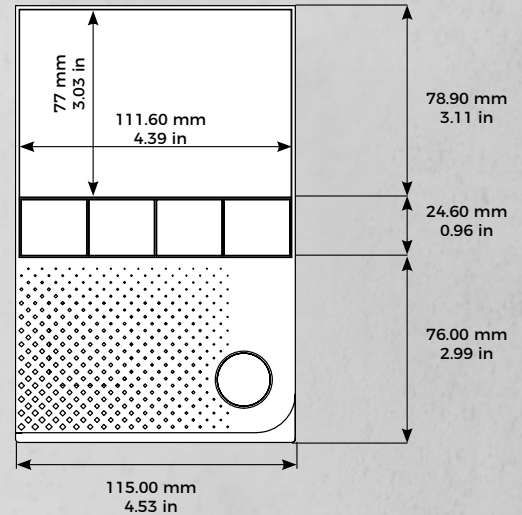

CURRENT SYSTEM REQUIREMENTS

System requirements	<p>Mobile device: Newest iOS on iPhone/iPad, newest Android on Smartphone/Tablet</p> <p>Internet: High-Speed Landline Broadband Internet connection, DSL, cable or fiber optic, no socks or proxy server</p> <p>Network: Ethernet Network, with DHCP</p>
Supported door stations	Any DoorBird IP Video Door Station

DISPLAY

Dimensions	4" True Color LCD
Touch	Yes, capacitive
Resolution	800 x 480 px
IPS	Yes

AUDIO

Audio components	Speaker and microphone, echo and noise cancellation (AEC, ANR)
Audio streaming	Two-way

NETWORK

Ethernet	PoE 802.3af Mode-A
WiFi	802.11 b/g/n 2.4 GHz

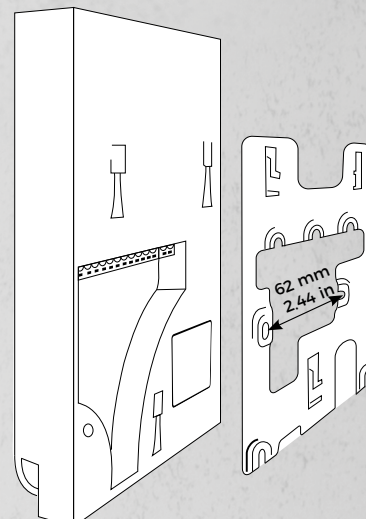

ONE INDOOR STATION VIA NETWORK CABLE

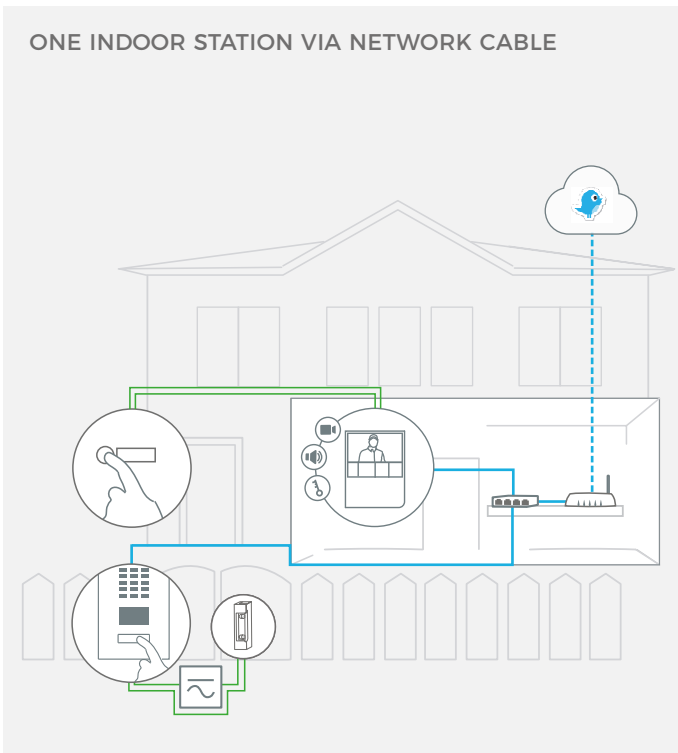

ONE INDOOR STATION VIA WIFI

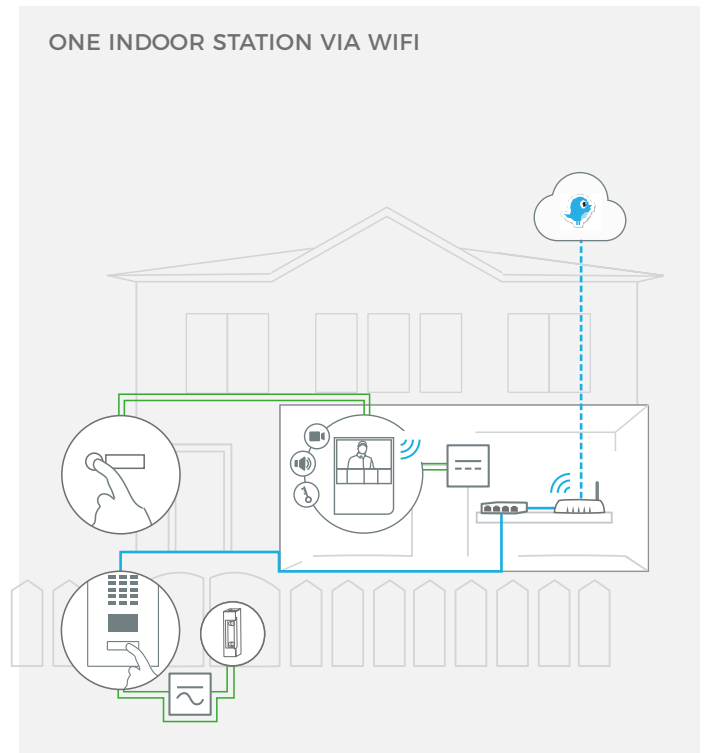

THREE INDOOR STATIONS VIA NETWORK CABLE

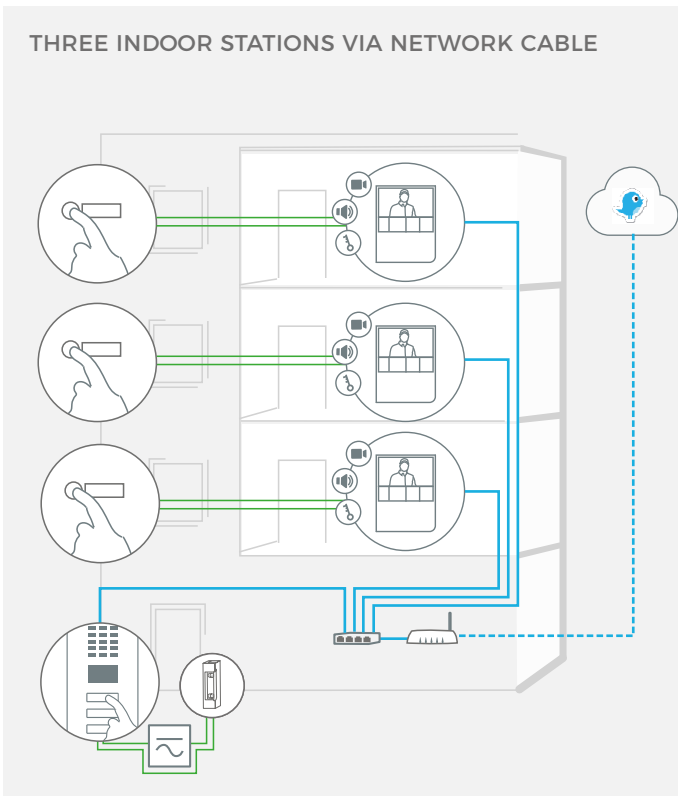

THREE INDOOR STATIONS VIA WIFI

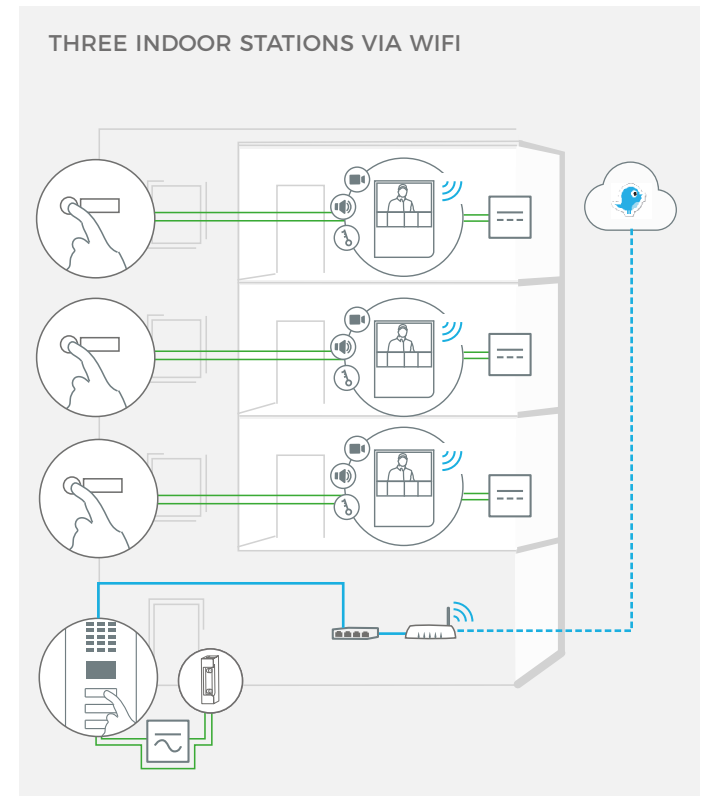

Storey-call button



Indoor Station



DoorBird IP Video Door Station



Electric door or gate opener. Can be secured via DoorBird I/O Door Controller if required (remote safety relay)



Power over Ethernet (PoE) Switch



Router with High-speed Internet, DHCP



Separate power supply 15 V DC, 1 A



Separate power supply 12 V DC, 1 A

— Network cable

— 2-wire-cable